

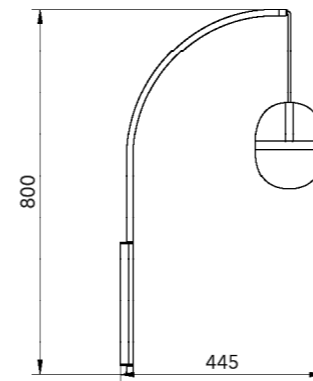

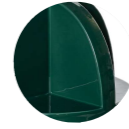



# HALF&HALF WALL

Design by Alain Gilles, 2022

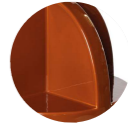

<b>Ceramic finish</b>	   
	<b>Green      Caviar      Toscan      Smooth</b>
<b>Glass finish</b>	
	<b>White opal</b>
<b>Source</b>	G9 led bulb 2x3,5w 700lm 2700K - CRI>90 (included)
<b>Dimming</b>	Dimmer on the cord
<b>Cord</b>	2000mm - black textile cable
<b>Mounting</b>	Wall
<b>Weight</b>	2,5 kgs net weight
<b>Structure material</b>	Aluminium
<b>Schade material</b>	Ceramic & mouth blown glass
<b>CE</b> <b>IP20</b>   220-240v	

	<b>COD</b>	<b>FINISH</b>
<b>Half&amp;Half</b>	HALF&HALF wall	Green & opal glass (N° 20101) Toscan & opal glass (N° 20102) Caviar & opal glass (N° 20103) Smooth & opal glass (N° 20104)